

RUBBER TRACKS

Bobcat Parts offer a wide variety of track sizes and patterns to satisfy your needs for any type of application



RUBBER TRACKS

Maximize your Bobcat equipment productivity with high performing and durable Genuine rubber tracks, engineered, tested and proven specifically for your Excavator or Track Loader to not only withstand the most challenging environments, but also to deliver a softer ride and traction needed to bring out the machine's full capabilities.

To make track selection easy, we simplified the Bobcat range and offer 2 main options to choose from – Premium and Standard – to suit your needs and preferences.

For maximum convenience, selected excavator tracks offer an extended warranty period of up to 24 months (or 2000 hours) or even 36 months (or 3000 hours).





BOBCAT PREMIUM RUBBER TRACKS

At Bobcat, we always recommend using genuine Premium Bobcat rubber tracks, the same product as used in our serial production, engineered and verified to provide the best performance and longest service life.

Thanks to our internal testing and partnering with the industry-leading suppliers we are making sure these are the best tracks available on the market for each Bobcat machine.

- Developed and tested specifically for Bobcat equipment.
- Superior quality rubber tracks used in serial production.
- Longest service life – ideal for high hours of construction work.
- Minimal vibrations for operators' comfort thanks to vibration-mitigating technology.
- Premium excavators' tracks come with extended warranty period up to 24 months or 2000 hours or even 36 months or 3000 hours.

BOBCAT STANDARD RUBBER TRACKS

We realize that the no-compromise approach to quality that we apply to Premium tracks comes with a price, which cannot always be justified in the eyes of the customer.

That's why we also offer a range of Bobcat Standard rubber tracks. These tracks are intended for less demanding applications, fewer hours of operation, or other situations in which the customer requires an economical solution with Bobcat quality.

- Ideal solution for older machines, lower operating hours or less demanding applications.
- Economical alternative to Premium tracks.
- Slightly adapted Bobcat approved tracks, developed to correspond with market value.
- Standard Loader tracks use the same favored "C" pattern as Premium.
- Standard tracks have an expected service life of 80% of the Premium tracks' service life, based on usage in moderate working conditions.

TRACKS DIMENSIONS

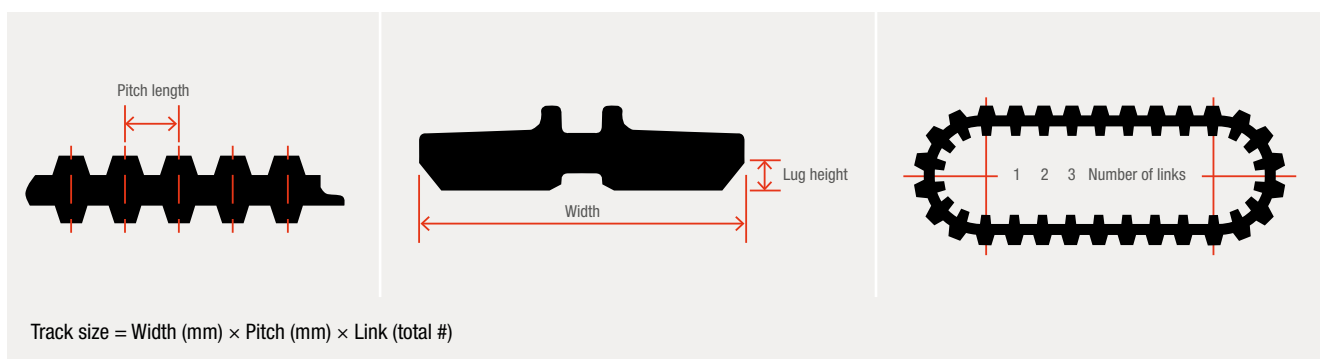

BOBCAT COMPACT EXCAVATOR TRACKS



While compact excavator tracks are commonly used at lower speeds, and for less aggressive applications than those for a compact tracked loader, they can also be subjected to the same demanding working conditions, which put a lot of stress on the tracks

Bobcat rubber tracks are designed to meet the operational and performance requirements of Bobcat excavators. Not only do they withstand tough operating conditions, they also provide a smooth ride and optimized operational costs, without sacrificing performance. Excavator rubber tracks come in 2 options for the majority of machines – Premium and Standard – each using the pattern selected with Bobcat’s and our manufacturers’ expertise.

| RUBBER TRACKS FOR COMPACT EXCAVATORS | | | | | |
|---|--|-------------|---------------|-------------|---------------|
| MODEL | TRACK SIZE (WIDTH × PITCH LENGTH × NO. OF LINKS) | PREMIUM | | STANDARD | |
| | | PART NUMBER | TREAD PATTERN | PART NUMBER | TREAD PATTERN |
| 316 | 180 × 72 × 38 | | | 7373948 | G |
| 418, E08, E10, E10e, E10z | 180 × 72 × 39 | 7255246 | E | 7373949 | F |
| 319, E14 | 180 × 72 × 41 | | | 7373950 | F |
| | 200 × 72 × 41 | 7365328 | K | | |
| 119, 120, 122 | 230 × 72 × 43 | | | 7373951 | G |
| 321, 323, E16, E17, E17z, E19 | 230 × 48 × 66 | 7259426 | D | 7373952 | H |
| E20, E20z | 230 × 48 × 72 | 7259427 | D | 7373953 | H |
| E25 | 250 × 52.5 × 76 | 7298190 | A | 7419905 | J |
| E26 | 250 × 52.5 × 80 | 7320132 | A | | |
| 225 | 320 × 100 × 40 | 6663953 | B | | |
| 225, 325, 328 | 300 × 52.5 × 74 | | | 7030471 | A |
| | 320 × 52.5 × 74 | 6672773 | A | | |
| 329, 331, 334, 428, 425, E26, E27, E27z, E32, E34 | 300 × 52.5 × 80 | 7243364 | A | 7373954 | I |
| E35 | 300 × 52.5 × 84 | 7275801 | A | 7373955 | I |
| 335, 430, E42 | 320 × 55 × 88 | | | 7373956 | E |
| 337, 341, 435, E45, E50, E55 | 400 × 73 × 74 | 7303382 | C | 7373957 | J |
| E60, E62 | 400 × 72.5 × 76 | 7365330 | C | 7373958 | J |
| 442 | 450 × 71 × 86 | | | 7373959 | J |
| E80, E85 | 450 × 81 × 76 | 7365331 | C | 7373960 | H |

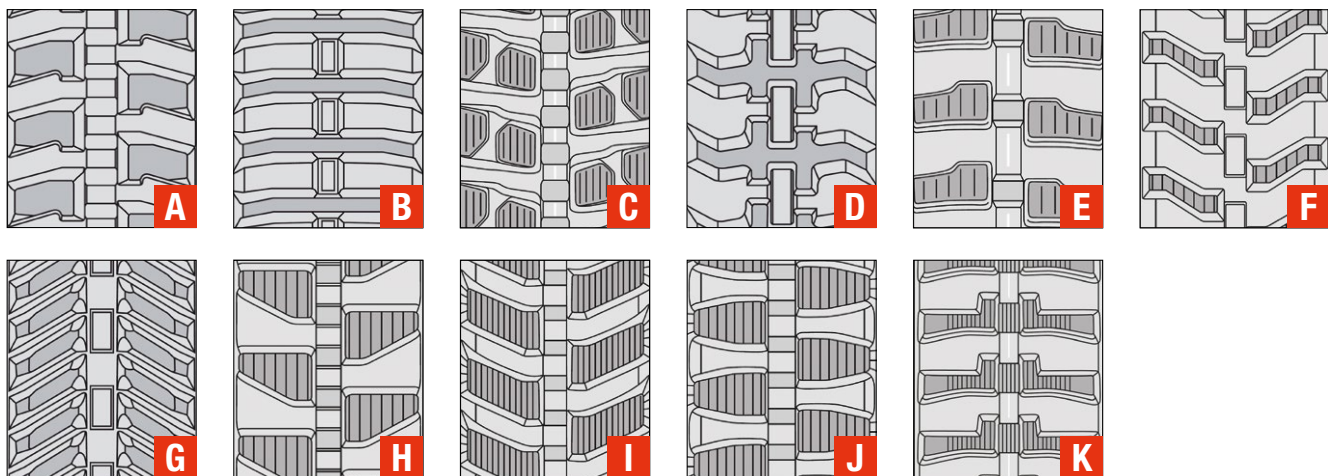

BOBCAT COMPACT TRACK LOADER TRACKS



Maximize your Bobcat Compact Track Loader performance with highly durable and Genuine Bobcat rubber tracks, designed to meet the most demanding expectations, provide a smooth ride and highest durability. Don't sacrifice ride comfort for added traction or longevity.

Bobcat tracks have been tested and proven to not only withstand the most challenging environments, but to also deliver a softer ride by distributing the machine's weight over a larger surface area. Our tracks offer the traction needed to bring out the loader's full capabilities.

| RUBBER TRACKS FOR COMPACT TRACK LOADERS | | | | | | | |
|---|--|-------------------|---------------|--------------------|---------------|---------------|---------------|
| MODEL | TRACK SIZE (WIDTH × PITCH LENGTH × NO. OF LINKS) | PREMIUM C PATTERN | | STANDARD C PATTERN | | MULTI BAR LUG | |
| | | PART NUMBER | TREAD PATTERN | PART NUMBER | TREAD PATTERN | PART NUMBER | TREAD PATTERN |
| MT55 | 180 × 72 × 39 | 7009964 | C | 7030470 | A | | |
| | 250 × 72 × 39 | 7009965 | C | | | | |
| T110 | 250 × 72 × 52 | 6688373 | C | 7419906 | C | | |
| T140, T450 | 300 × 84 × 46 | 6682177 | C | 7419907 | C | | |
| | 320 × 84 × 46 | | | | | 6987675 | B |
| T180, T190, T590 | 320 × 86 × 49 | 6680161 | C | 7316758 | C | | |
| | 320 × 84 × 50 | | | | | 6988318 | B |
| | 400 × 86 × 49 | 6685650 | C | 7316759 | C | 7030194 | B |
| T650 | 320 × 86 × 52 | 6680149 | C | 7316760 | C | | |
| | 320 × 84 × 53 | | | | | 7261331 | B |
| | 450 × 86 × 52 | 6680150 | C | 7316761 | C | | |
| | 450 × 84 × 53 | | | | | 6988320 | B |
| T66 | 400 × 86 × 50 | 7324236 | C | 7408148 | C | 7408151 | B |
| T76 | 450 × 86 × 53 | 7301305 | C | 7396438 | C | 7359650 | B |
| T250, T300, T320, T770 | 320 × 86 × 55 | 6678748 | C | 7316762 | C | | |
| | 450 × 86 × 55 | 6678749 | C | 7316763 | C | 7320105 | B |
| T870 Roller Suspension | 450 × 86 × 58 | 7277043 | C | 7316764 | C | | |
| | 450 × 84 × 60 | | | | | 6989042 | B |
| T870 Torsion Suspension B47C, B47L, B47H | 450 × 60 × 86 | 7266334 | C | 7316765 | C | | |

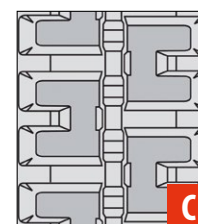
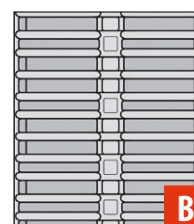
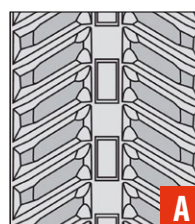

LOADERS TRACKS THREAD PATTERNS

For loaders, we stick to the proven 'C' pattern across the machines' range, offered in both Premium and Standard versions. If increased traction in wet or loose conditions is needed, we offer the 'MBL' track pattern.

The choice between Narrow or Wide 'C' tracks gives you the option to adapt the machine's characteristics according to terrain or application. For increased ground pressure, added traction and more pushing force, choose a narrow track. Wide tracks are a good choice when lower ground pressure and flotation are desired.



PREMIUM C-PATTERN

The best durability and performance the market has to offer in all-season use. One of the most versatile, no compromise, tracks used in serial production. Provides superior traction in most applications.

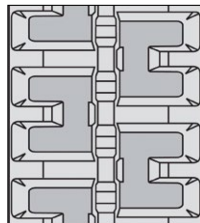

Recommended uses:

- Great for all high hours construction work and heavy-duty applications.
- Excellent in dirt, mud, rock, and demolition.
- Not recommended for snow.

STANDARD C-PATTERN

The track offers durability and traction in all-season use in a more economical package. It is the same pattern as used in production and one of the most versatile on the market, performing well in all different types of applications.

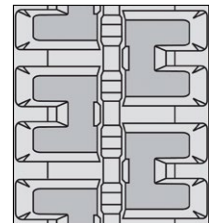

Recommended uses:

- Great for all general construction work.
- Excellent in dirt and mud.
- Not recommended for snow or extremely rocky conditions.

MULTI-BAR LUG PATTERN

Durable all-season track that provides superior traction in wet conditions and extended wear life on hard flat surfaces.

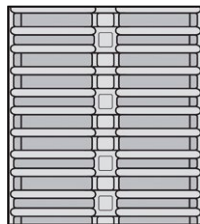

Recommended uses:

- Great for all general construction work.
- Excellent in sand and dirt or snow.
- Not recommended for extremely rocky conditions.

V-SHAPED PATTERN

Deep V-shaped tread pattern (inspired by agricultural tracks) provides outstanding traction in muddy and soft dirt applications, while providing a stable, comfortable ride and excellent clean-out.

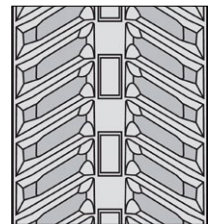

CHOOSING THE RIGHT TRACKS FOR COMPACT TRACK LOADERS

At Bobcat, we always recommend using Bobcat rubber tracks instead of uncertified, unapproved tracks

The manufacturing technology is a sophisticated combination of special kinds of rubber, vulcanized along with steel embeds and loops of steel cords. Designing the right shape, pattern, depth and well-specified rubber materials guarantees long life, low ground pressure, and high traction. Thanks to our expertise in testing, we always collaborate with our Bobcat suppliers to optimize the components for our machines – and the rubber tracks are no exception.



USE GENUINE BOBCAT RUBBER TRACKS TO GET THE MOST OUT OF YOUR INVESTMENT

With genuine Bobcat rubber tracks, you will benefit from lower operational costs and highest productivity. Furthermore, they offer more comfort and longer tread wear than uncertified, unapproved aftermarket tracks. Follow the recommendation below to choose the best track for your application and expected operating hours.

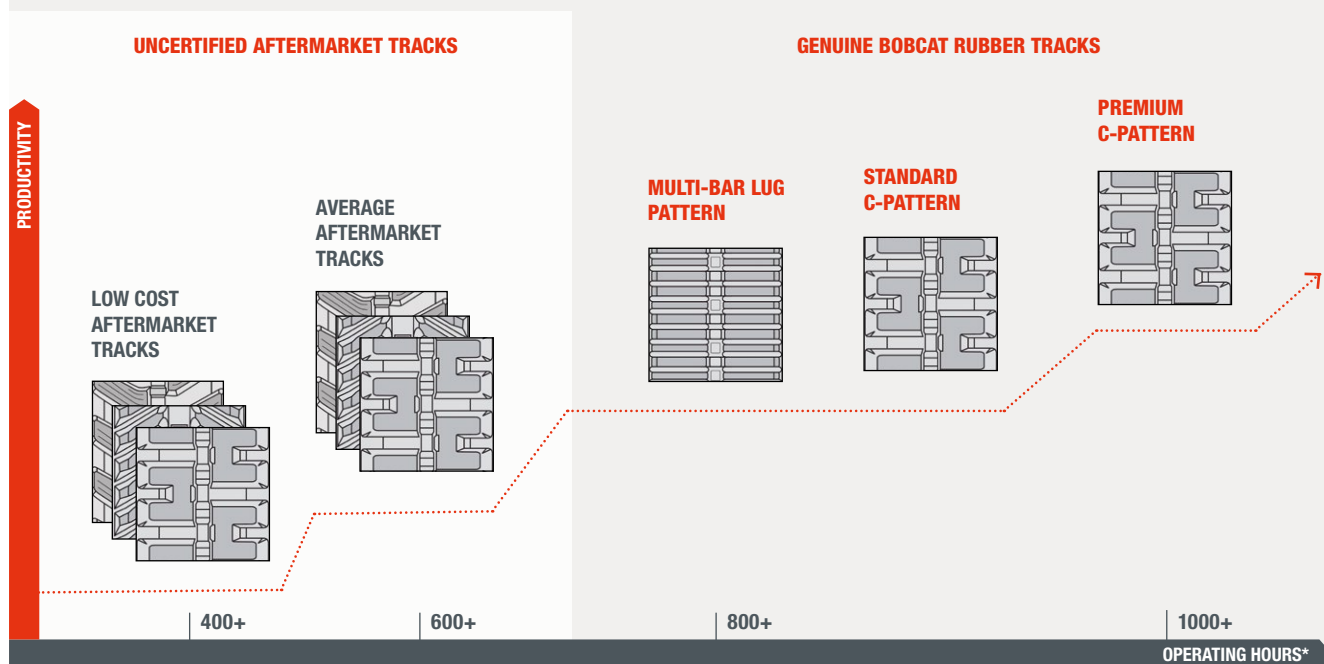

* Hour ratings listed above are based on usage in moderate working conditions

| | ROCK | DIRT | SAND | CONCRETE | DEMOLITION | TURF | SNOW | MUD | SLOPED | CLAY |
|-----------------------|------|------|------|----------|------------|------|------|-----|--------|------|
| PREMIUM C-PATTERN | ● | ● | ● | ● | ● | ● | ○ | ● | ● | ● |
| STANDARD C-PATTERN | ● | ● | ● | ● | ● | ● | ○ | ● | ● | ● |
| MULTI-BAR LUG PATTERN | ● | ● | ● | ● | ○ | ● | ● | ● | ○ | ● |

BEST ● BETTER ● GOOD ○

RUBBER TRACKS DAMAGE PREVENTION AND MAINTENANCE

Even though Bobcat machines operate in the harshest conditions, it is important to avoid improper applications or usage in combination with poor maintenance and incorrect track tension.

To achieve optimal track tension, we test and validate the correct interaction with undercarriage components. Our specialized engineering and testing teams conduct rigorous and demanding validation processes, both in the laboratory and in the field.

For performance and durability field tests – in real-life conditions with mud, sand and rocks – we use our testing polygon with which we focus on common failure modes and simulate extreme operation of the machine – such as working in rocky conditions, driving over a curb, steep slope retention, and simulating de-tracking.

EXCAVATOR USAGE LIKELY TO CAUSE TRACK DAMAGE WHILE RECOMMENDED TENSION AND SYSTEM CONDITIONS AREN'T MAINTAINED.



SHARP OBJECTS
Risk of damaging lugs and main cable.



UNEVEN SURFACES
Risk of detacking with lug/core damage.



SLIPPAGE
Load & speed appropriate to avoid rapid tread wear.



HITTING WITH BUCKET
Risk of lug, core and/or main cable damage.

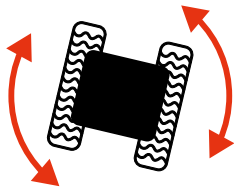

SPOT TURNING
Risk of detacking with possibility of lug and core damage.



OPERATION ON A SLOPE
Risk of detacking or excessive damage to lugs.



TRACK EDGE IN CURBLINE
Extreme side wear and possible damage to iron core.

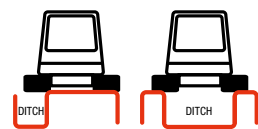

MACHINE ASTRIDE A TRENCH
Possible lug and/or iron core damage.

- Maintaining recommended track tension as described in the machine's operation manual helps maximize the track life. Regular cleaning and maintenance of the entire track system is essential to ensure a long lifespan.

- Warranty covers defects in material and workmanship but not damage from use or installation because of misapplication, misuse, negligence, alteration, accident, field and road hazard, overload, mismatching of opposite side tracks, use of non-genuine undercarriage components, or poor mechanical condition, maintenance or adjustment.

BOBCAT PREMIUM EXCAVATOR TRACKS WARRANTY CONDITIONS

Selected bobcat premium excavator rubber tracks are covered by warranty for up to 36 months (or 3000 hours) for the highest convenience and peace of mind. The warranty covers disabling defects in materials and workmanship that appear under proper usage conditions.



ELIGIBILITY

- Original owner of new Bobcat Premium Excavator Rubber Track purchased through an authorized Bobcat Aftermarket Parts dealer.
- Factory-fitted Bobcat Rubber Tracks are excluded from this prolonged warranty program, which is an Aftermarket-only program.

COVERAGE

- Bobcat Premium Excavator Rubber Track is warranted, from date of the installation on the machine, against defects in materials and workmanship.
- Bobcat Premium Excavator Rubber Track that becomes unserviceable as a result of a defect in materials or workmanship, as determined by Bobcat, will be replaced, or an allowance will be given towards the purchase of a replacement Bobcat track, at Bobcat's choice.



EXCLUDED FROM COVERAGE

- Track no longer owned by the original purchasing end user.
- Claims outside the listed months of service or hours limit coverage.
- Track manufactured more than 60 months prior to warranty request.
- Damage from use or installation as a result of misapplication or exceeding the specifications of the track original design capabilities.
- Failure resulting from abuse, misuse, negligence, alteration, accident, field, road hazard, or stubble damage, overload, mismatching of opposite side tracks, misapplication, or use of non-OEM undercarriage components, or poor mechanical condition, maintenance or adjustment.
- Cosmetic defects, such as surface cracks, splits and other superficial distress that may impact track appearance but do not render the track unusable or measurably diminish overall life.
- Usage, installation, repair or adjustment which Bobcat judges improper.



24 months / 2000 hours or
36 months / 3000 hours
WARRANTY

OWNERS OBLIGATIONS AND SUPPORTING DOCUMENTATION FOR WARRANTY CLAIMS

- Giving notice of failure within applicable warranty period.
- Providing valid proof of purchase.
- Providing supporting photo documentation:
 - Photos of entire machine including model and series
 - Several clear, close up photos to identify suspected defective areas
 - At least one clear view of entire track including view of suspected defective area
 - Photos of logo, part number, serial number, and country of manufacture
- Submission of claim request within 60 days of the failure.
- Transportation cost to warranty service location. Freight charges if applicable.
- Installation costs and taxes.
- Undercarriage components properly maintained and adjusted.

BOBCAT PREMIUM TRACKS WARRANTY LIMITS

| WARRANTY CONDITIONS | | | |
|---------------------|-------------|-------------------|-------------|
| MODEL | PART NUMBER | MONTHS OF SERVICE | HOURS LIMIT |
| E08, E10 | 7255246 | 24 | 2000 |
| E14 | 7365328 | 24 | 2000 |
| E17, E17Z, E19 | 7259426 | 24 | 2000 |
| E20 | 7259427 | 24 | 2000 |
| E25 | 7298190 | 24 | 2000 |
| E25 (K2) | 7320132 | 24 | 2000 |
| E26, E32 | 7243364 | 24 | 2000 |
| E35 | 7275801 | 24 | 2000 |
| E45, E50, E55 | 7303382 | 24 | 2000 |
| E60, E62 | 7365330 | 36 | 3000 |
| E80 | 7365331 | 36 | 3000 |

Hours / Months – whichever comes first. If months of service are not known, manufacturing date will be used.



BE OM **EN OFFERT**

Klicka bara på **knappen** eller skanna **QR-koden** nedan för åtkomst till vårt offertformulär.

Vi kontaktar dig så snart som möjligt. Tack!



BEGÄR OFFERT

